

V-TECH TOURING PARA - TOURING V-TECH FOR - V-TECH TOURING FÜR YAMAHA XMAX 300

Ref.: 9476

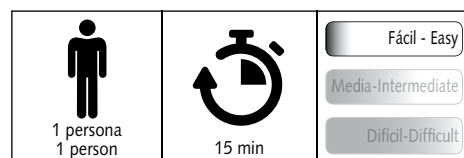
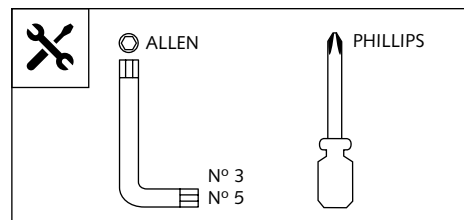

ID	PIEZA / PART	DESCRIPCIÓN	DESCRIPTION	QTY	REF.
1		V-Tech Touring	Touring V-Tech	1	9476H/F/WM3
2		Tornillo Allen M6x50 DIN 912	M6x50 DIN 912 Allen screw	2	TORNI-D912--473
3		Tornillo Allen M6x35 DIN 912	M6x35 DIN912 Allen screw	2	TORNI-D912--447
4		Casquillo Ø8,5 x Ø14 x 9	Ø8,5 x Ø14 x 9 Arrowhead	4	CASQUI-----0100
5		Tornillo Allen M5x25 Ø11 ISO 7380	M5x25 Ø11 ISO 7380 Allen screw	4	TORNI-I7380-766
6		Arandela de nylon M5x1	M5x1 nylon washer	4	ARNV00000000245
7		Tapón tornillo M5 ISO 7380	M5 ISO 7380 Allen screw cap	4	TAPON_____85
8		Arandela de goma Ø4,5 x Ø14 x 4mm	4,5 x Ø14 x 4mm rubber washer	4	ARAND-GD13D5X4-

MONTAJE DE LA CÚPULA EN POSICIÓN BAJA

SCREEN ASSEMBLY ON LOW-POSITION

Posición BAJA

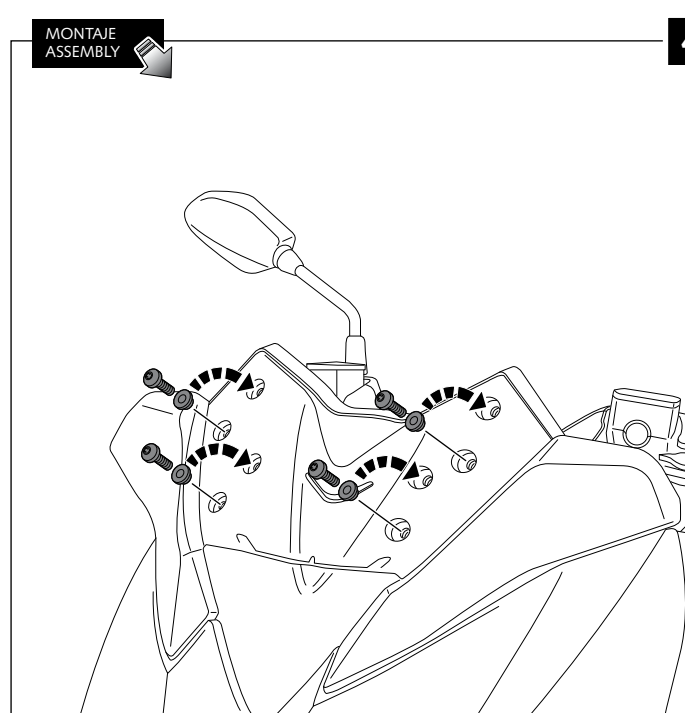
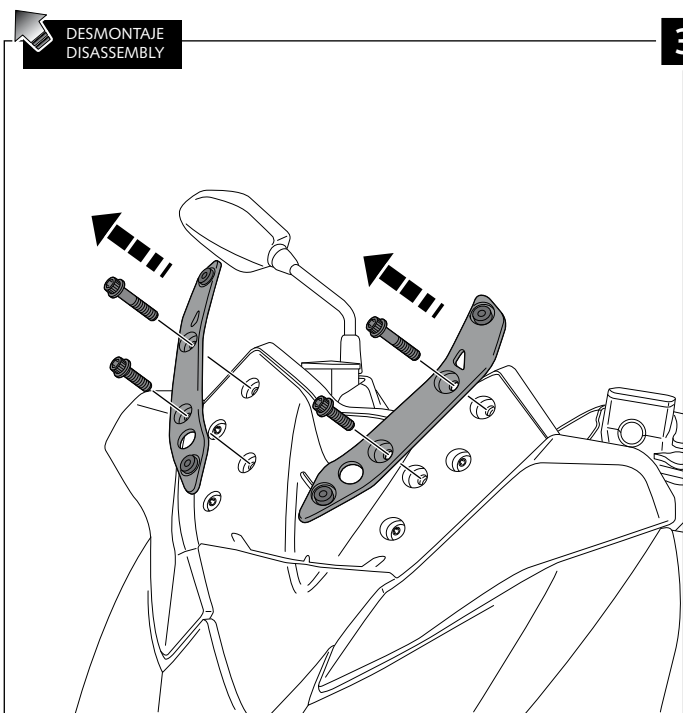
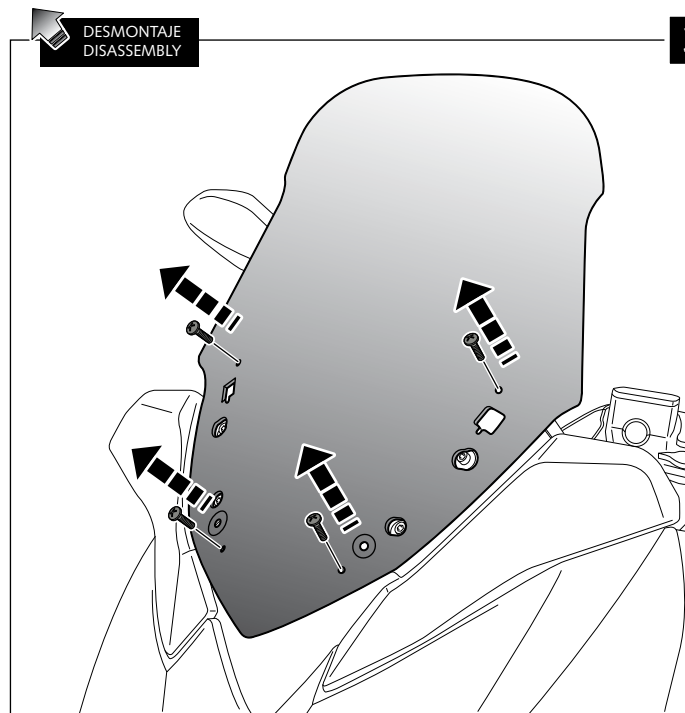
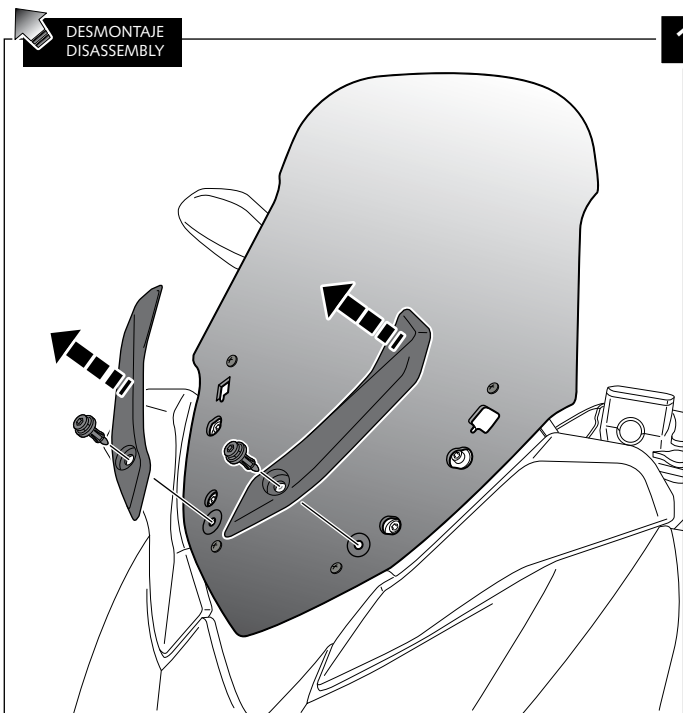
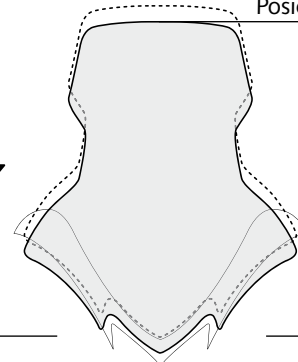

MONTAJE DE LA CÚPULA EN POSICIÓN BAJA

SCREEN ASSEMBLY ON LOW-POSITION

Posición BAJA

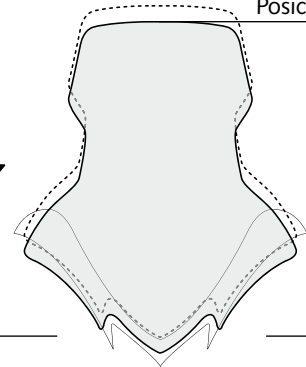

MONTAJE ASSEMBLY

5

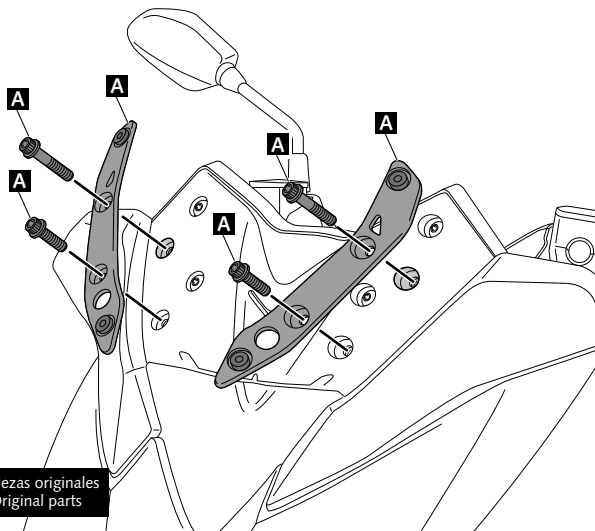

6

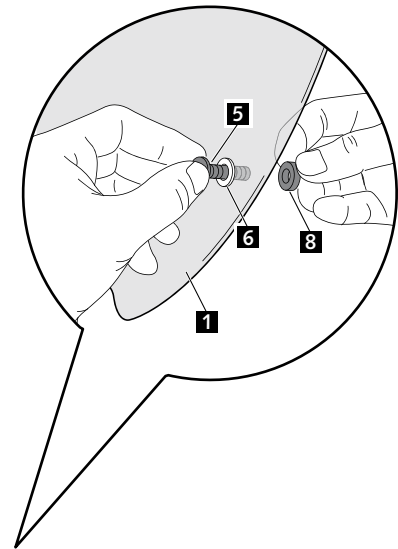

MONTAJE ASSEMBLY

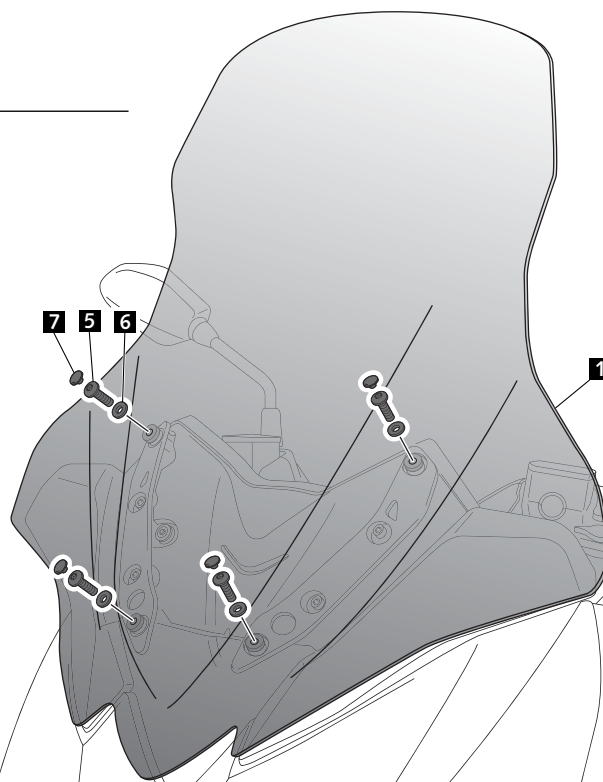

Posición ALTA

MONTAJE DE LA CÚPULA EN POSICIÓN ALTA

SCREEN ASSEMBLY ON HIGH-POSITION

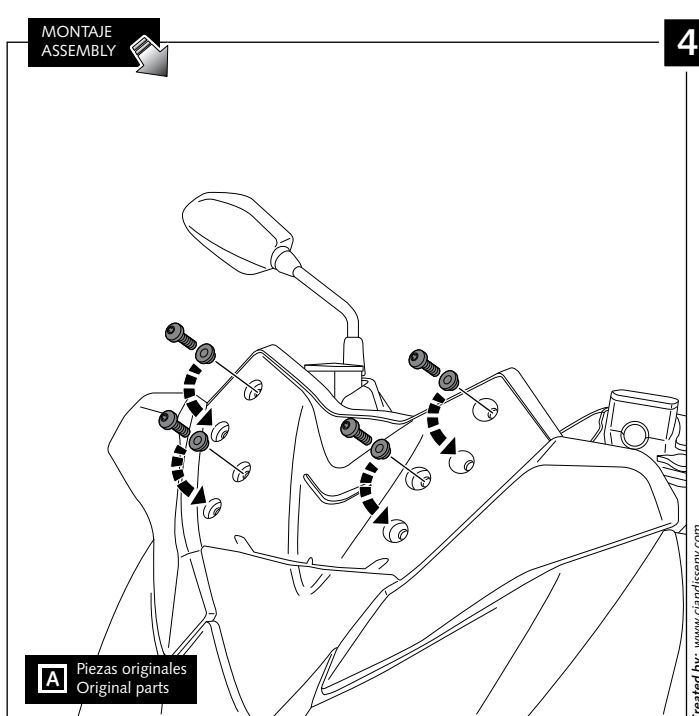
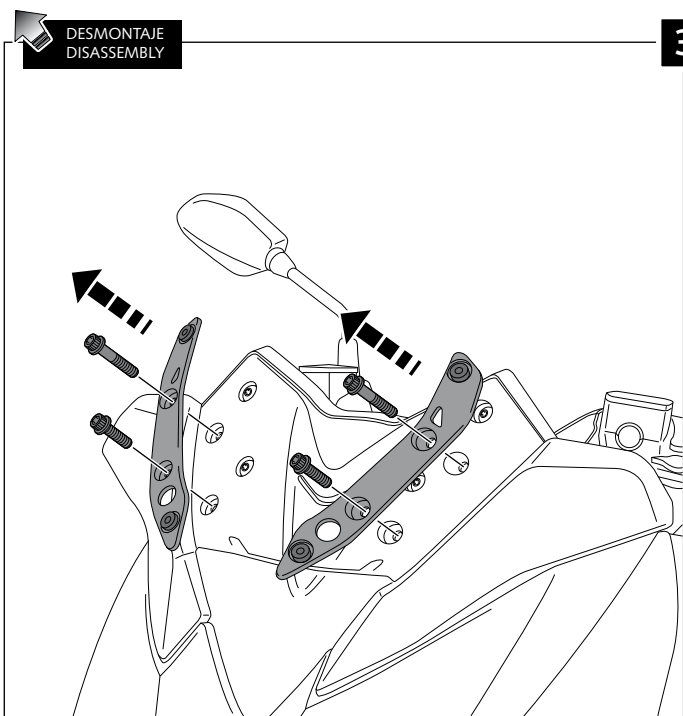
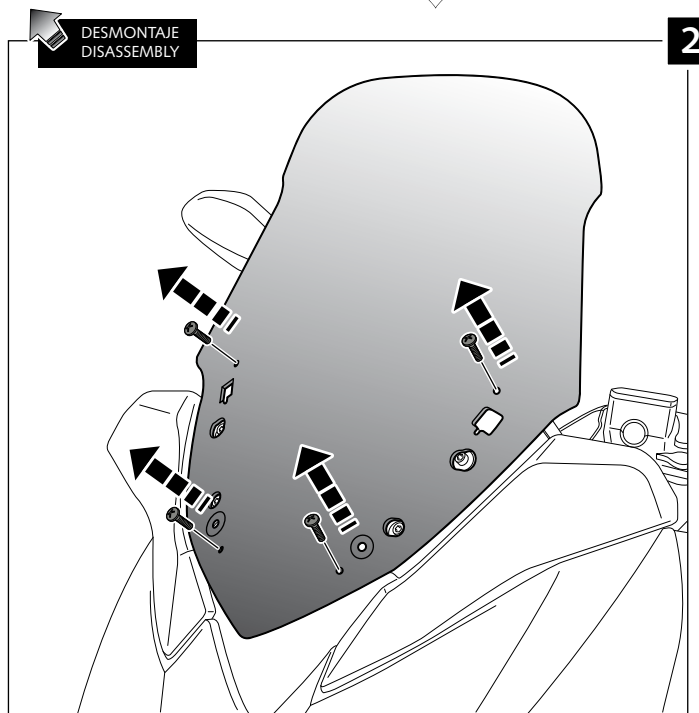
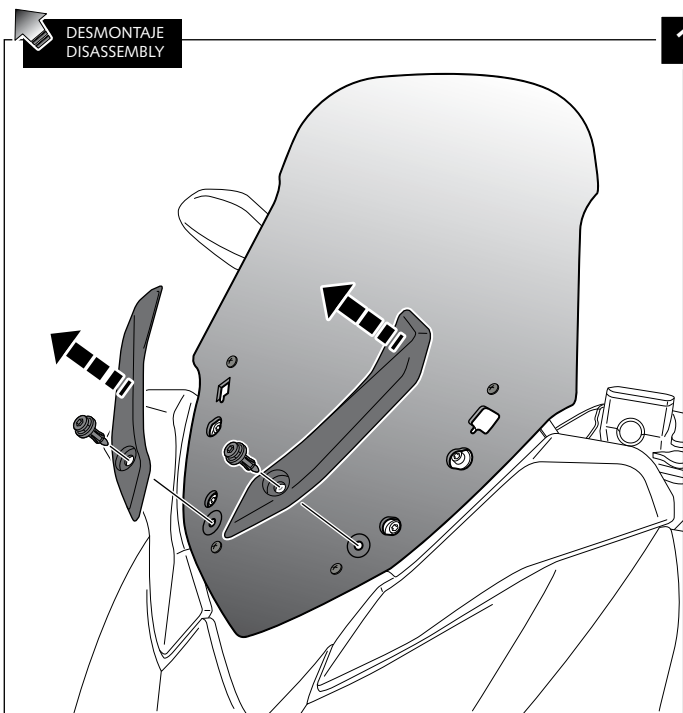
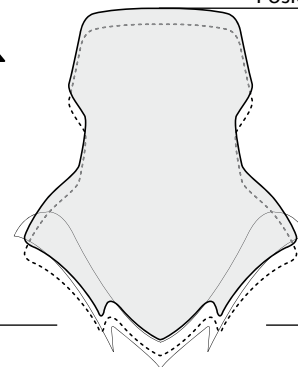
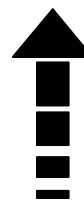

Posición ALTA

MONTAJE DE LA CÚPULA EN POSICIÓN ALTA

SCREEN ASSEMBLY ON HIGH-POSITION

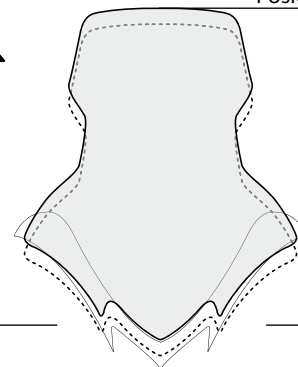
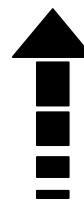

MONTAJE ASSEMBLY

5

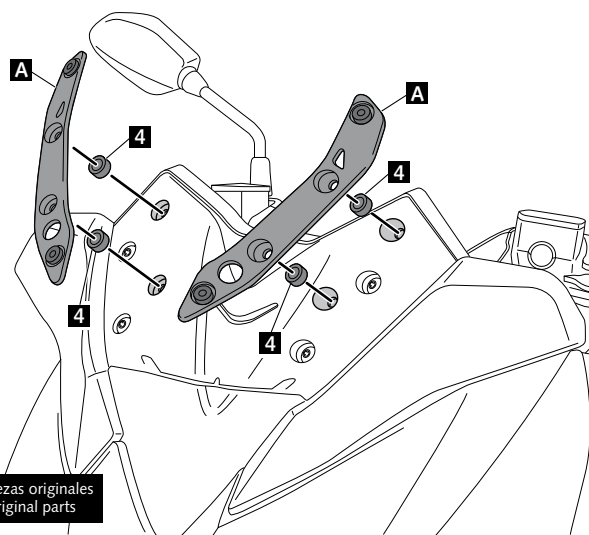

A Piezas originales
Original parts

MONTAJE ASSEMBLY

6

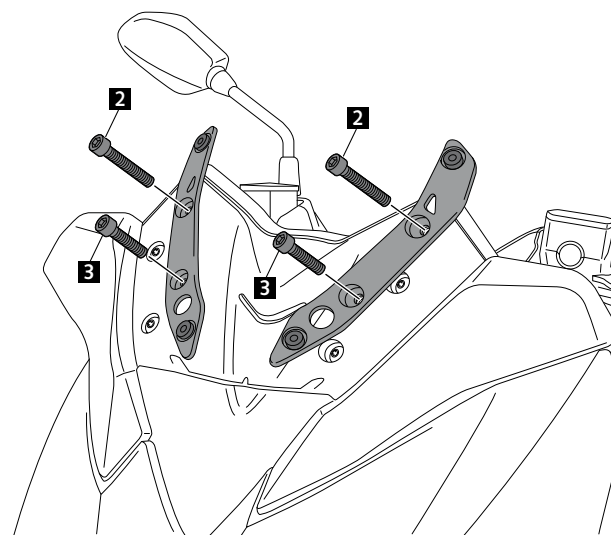

MONTAJE ASSEMBLY

7

